

Manual (V1.0)

PT100 series Mini vector inverter



Introduction

Thank you for choosing PT100 variable-frequency inverter of Shenzhen Powtech Co.,Ltd. This product is a smart mini vector inverter based on years of research and development, production and sales experience in Powtech, using high-quality components, materials and incorporating the latest digital control technology, which is , reliable and widely used with stable performance.

This introduction includes PT100 series single phase 220V(0.4-2.2Kw), three phases 220V(0.4-2.2Kw) and three phases 380V(0.4-2.2Kw).

This specification provides related notices, such as parameter setting of installation and operation, diagnosis of malfunctions, daily maintenance and safe use, for user. Please read this operation introduction in detail before install it in order to guarantee install and operate this variable-frequency inverter correctly.

Please contact with dealers of our company in various places or directly contact with our company if there is any difficult during your using process; and our professionals are glad to make service for you!

Please submit this introduction to ultimate user and ask the user to keep it properly, which will be beneficial for later maintenance and other applied occasions. If there is any trouble during the warranty period, please fill in the warranty card and fax it to the dealer or our company.

The information may be changed during the improving period of this project without prior notice. Please consult the

website of our company if you want to obtain the latest information.

Please consult <http://www.powtech.cn> for information of our other products.

Shenzhen Powtech Co.,Ltd

CATALOGUE

Chapter 1 Inspection and Safety Precautions	1
1-1 Inspect after unboxing.....	1
1-1-1 Explanative to nameplate	1
1-1-2. Type instruction	1
1-2 Safety attentions.....	2
1-3. Precautions.....	7
1-4 Range of application	11
Chapter 2 Standard specification	13
2-1 Technical specifications	13
2-1-1. Technical specifications of PT200	13
2-1-2 See the following table for rated output current with different specifications	13
2-2 Standard specification	14
2-3. Dimension.....	22
2-3-1 outline drawing of the product and dimension of installing hole	22
2-3-3. Dimension figure of keyboard	24
Chapter 3 Installation and redundant circuit	25
3-1 Service environment	25
3-2 Installation direction and room	25
Chart 3-1 installation direction and room.....	26
3-3 Wiring diagram	26
3-3-1 Wiring diagram below 2.2KW (1S2)	27
Chart 3-2 Wiring diagram below 2.2KW.....	27
3-4. Main circuit terminal (G type)	28
3-4-1.Main circuit terminal of PT100.....	28
3-4-2 Explanation for the function of terminal blocks	28
3-5 Control circuit terminal	29
3-5-1. Explanation for control circuit terminal	29

3-5-2. Arrangement of control circuit terminal.....	30
3-6 Wiring precautions.....	30
3-7 Redundant circuit.....	32
Chapter 4 Operation keyboard.....	34
4-1. Introduction of operation keyboard	34
4-2. Introduction for indicator light of the keyboard.....	34
4-3. Key description of operation panel	36
4-4. Menu style	37
4-4-1. First-level menu style	38
4-4-2. Form of secondary menu	39
4-4-3. Form of three-level menu	39
4-4-4. Common display symbol of LED	40
4-4-5. LED displays corresponding sign	41
4-5. Password operation and key.....	42
4-6. Display of operation panel and key operation.....	44
4-6-1. Classification of display state: display state of operation panel can be divided into 9 types:	44
4-6-2. Display status and of operation process.....	45
Chapter 5 Commissioning.....	47
Chapter 6 Instruction of function parameter	50
6-1. List of function parameter.....	50
6-1-1. Menu grouping	52
6-1-2. P00 group Monitoring function group	54
6-1-3. P01 group Basic group	57
6-1-4. P02 group Control group for the stop and start.....	61
6-1-5. P03 group: Group of electric machine parameter.....	62
6-1-6. P04 group Vector control parameter	64
6-1-7. P05 group V/F control parameter	65
6-1-8. P06 group Input terminal group.....	68
6-1-10. P08 group output terminal group.....	77
6-1-11. P09 group Enhancement group.....	80

6-1-12. P10 group control group of PID.....	82
6-1-13. P11 group control group of multistep speed.	84
6-1-14. P12group communication parameter group	86
6-1-15. P13 group Protection function group	89
6-1-16. P14 group function group of water supply	91
6-1-17. P15 group manufacturer's function group.	91
Chapter7 EMC(Electro Magnetic Compatibility)	92
7-1. Definition	92
7-2. Introduction of EMC standard.....	92
7-3.EMC guidance	93
7-3-1. Influence of harmonic wave.....	93
7-3-2.Electromagnetic interference and installation notes	93
7-3-3. Solution for the interference of surrounding electromagnetic equipment on AC frequency vector inverter ..	94
7-3-4. Solution for the interference of AC frequency vector inverter on its surrounding electromagnetic equipment.....	95
7-3-5. Leakage current and disposal.....	96
7-3-6. Precautions for installing EMC input filter at the input terminal of the power supply :	97
Chapter 8 Failure checking and removal	99
8-1. Failure information and removal method.....	99

Chapter 1 Inspection and Safety Precautions

All inverter of Shenzhen Powtech Co.,Ltd are given strict test and quality inspection before the leave the factory. Please firstly check whether the product package is damaged due to transportation carelessness after your purchasing and whether the specification and type is consistent with the machine you ordered. Please contact with dealers of our company in various places or directly contact with our company if there is any problem.

1-1 Inspect after unboxing

Inspect it includes one machine, an manual and a warranty card. Inspect name board at the side of variable-frequency inverter to confirm the product you obtain is the product you ordered.

1-1-1 Explanative to nameplate

- Inverter type →
- Input voltage specifications →
- Power output specifications →
- Production serial number →

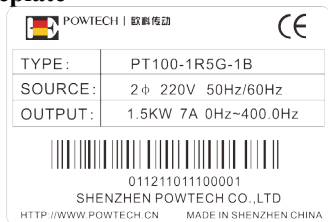

1-1-2. Type instruction

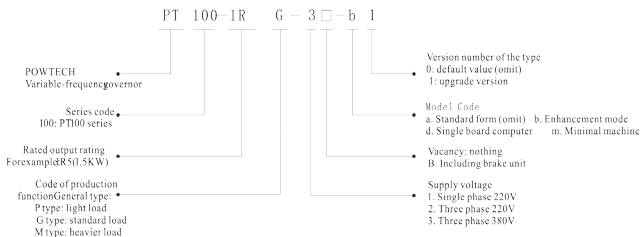

1-2 Safety attentions







Safety precautions is divided into following two types in this manual:



Danger: the danger caused by not operating as required can cause serious injury or even death.





Notice: the danger caused by not operating as required can cause moderate harm or minor injury and damage of the equipment

Process	Type of safety matters	Content of safety precautions
Preinstallation	 danger	<ul style="list-style-type: none"> ● Please don't install when it is found that control system has water, the part is insufficient or damaged when the box is opened. ● Please don't install when the packing list is inconsistent with the matter time! ● Lift and put lightly when it is moved, or there will be danger of destroying the equipment! ● Please don't use the actuator with damage or AC frequency vector inverters with missing parts, or there will be danger of being injured! ● Don't touch the component of the control system with your hand, or there will be danger of static destroy!
Installation	 danger	<ul style="list-style-type: none"> ● Please install on flame retardant objects like metal; Be far away from combustible material. Or it may cause fire alarm! ● Don't screw fixed bolt of the equipment component randomly, particularly the bolt with red sign!
	 notice	<ul style="list-style-type: none"> ● Don't drop wire head or screw into the actuator. Or it may cause the damage of the actuator! ● Please install the actuator at a certain place with litter vibration and direct sunlight. ● Please pay attention to the installation location when put two inverter into one cabinet to guarantee the effect of heat dissipation.

<p>Wiring</p>		<ul style="list-style-type: none"> ● Please follow the guidance of this manual and the construction should be made by professional electrical engineering staff, or unexpected danger will appear! ● AC frequency vector inverters and power source should be separated by circuit breaker, or it may cause fire alarm! ● Please confirm that the power source is at zero energy state before the wiring, or it will have electric shock hazard! ● Please make a correct and standard ground connection for the AC frequency vector inverters based on the standard, or it will have electric shock hazard! ● Never connect input power with output terminals (U, V and W) of the transducer. Pay attention to the sign of terminal blocks; don't connect the wire with mistake, or it may cause the damage of the actuator! ● Make sure circuit matched meets the requirement of EMC and the safety standard in its region. Please refer to the suggestion of this manual for wire diameter of the wire used. Or it may have accident! ● Never connect break resistor between (+) and (-) terminals of DC bus, or it may cause fire alarm! ● Encoder must use shielded wire; moreover, shielding layer must guarantee reliable ground connection of a single terminal.
----------------------	---	---

Before electrifying	 notice	<ul style="list-style-type: none"> ● Please confirm whether the voltage class of input power is consistent with rated voltage class of transducer, whether the circuit connected is firm enough, or it may cause the damage of the actuator! ● There is no need in making pressure test for any part of the transducer; the product is made such as test when it leaves the factor, Or it may have accident!
	 danger	<ul style="list-style-type: none"> ● The AC frequency vector inverters must be electrified after its covered plates is covered well. Or it will have electric shock hazard! ● The wiring of all outside accessories must strictly follow the guidance of this manual; and their wirings should be connected correctly based on the circuit connect menthol provided by this manual. Or it may have accident!
After electrifying	 danger	<ul style="list-style-type: none"> ● Don't open the cover plate after the electrifying. Or it will have electric shock hazard! ● Don't use a wet hand to touch actuator and peripheral circuit.. Or it will have electric shock hazard! ● Don't touch any input or output terminal of the transducer. Or it will have electric shock hazard! ● At the beginning of electrifying, the AC frequency vector inverters will automatically make a security detection for outside return circuit of the strong current; at that time, never touch U, V and W terminal blocks of the actuator, or it will have electric shock hazard!

		<ul style="list-style-type: none"> ● Parameter identification should be made and please pay more attention to the hazard hurting people during the rotation of electric machine. Or it may have accident! ● Please don't change manufacturer's parameter of the AC frequency vector inverters randomly. Or it may have hazard of damaging the equipment!
In service	 danger	<ul style="list-style-type: none"> ● Never touch the cooling fan or discharge resistance to feel out the temperature. Or it may cause burning. ● Non-professional technician can't detect the signal during the operation process. Or it may cause personal injury or equipment damage!
	 notice	<ul style="list-style-type: none"> ● Anything should be avoided to drop into the equipment during the operation process of the transducer. Or it may cause equipment damage! ● Don't use contractor switching to control the start and stop of the actuator. Or it may cause equipment damage!
Maintenance	 danger	<ul style="list-style-type: none"> ● Please don't repair and maintain the equipment with electricity. Or it will have electric shock hazard! ● Maintenance and preparing can be made to the actuator only after confirming the AC frequency vector inverters voltage is lower than 36V, subject to two minutes after power failure. Or residual charge on capacitance will harm people. ● Anybody without professional training can't make maintenance or preparing to the transducer. Or it may cause personal injury or

		<p>equipment damage!</p> <ul style="list-style-type: none"> ● Parameter setting must be made after changing the transducer; all pluggable parts must be inserted or seized under the condition of power failure!
--	--	---

1-3. Precautions

N o.	Types of attention	Precautions contents
1	Insulation inspection of the motor	Insulation inspection of the motor should be made for the initial use of the motor, reusing after long-term placing when the motor is used or given regular inspection to avoid damaging the AC frequency vector inverters due to the insulation failure of machine winding, motor connection must be separated with the AC frequency vector inverters when insulation inspection is made; it is suggested to use megameter with 500V voltage type and guarantee the insulation resistance detected can't be smaller than 5M Ω .
2	Thermal protection of the motor	Make sure to adjust relevant parameter value of motor protection in the AC frequency vector inverters or install thermal relay before the motor to protect the motor when the rated capacity of the selected motor doesn't match with that of the transducer, particularly when the rated power of the AC frequency vector inverters are bigger than that of the motor.
3	Operation above the power frequency	This AC frequency vector inverters can provide 0Hz~400Hz output frequency. If the customer wants to make operation above 50 Hz, please take the endurance of the mechanical device into consideration.

No.	Types of attention	Precautions contents
4	Vibration of mechanical device	The setting for hopping frequency in the AC frequency vector inverters can be used to avoid mechanical resonance point of the load device which might be met by the AC frequency vector inverter sat some locations of output frequency.
5	About heating and noise of the motor	Compared with the operation of power frequency, the temperature rise, noise and vibration of the motor will increase slightly because the output voltage of the AC frequency vector inverter's PWM wave.
6	Pressure-sensitive device or capacitance improving the power factor at the output side	If the side the AC frequency vector inverters has capacitance improving the power factor or voltage dependent resistor for lighting protection, it will cause instant over current of the AC frequency vector inverters or damage the AC frequency vector inverters because the output voltage of the AC frequency vector inverters is PWM wave. Please don't use it.
7	Switching element such as contactor used by input and output terminal of the transducer	If contactor between the power supply and input end of the AC frequency vector inverters is installed, then it won't allow this contactor to control the start and stop of the transducer. If it is necessary to use this contactor to control the start and stop of the transducer, the interval can't be bigger than one hour. Frequent charge-discharge easily shortens the service life of the capacitor in the AC frequency vector inverters. If switching element such as contactor installed between output terminal and the motor, it should be guaranteed that the switching operation of the AC frequency vector inverters should be made without output. Or it easily causes the module damage in the transducer.

N o.	Types of attention	Precautions contents
8	Use beside rated nominal voltage value	It is improper to use PT100 AC frequency vector inverters by and the voltage range stipulated in this manual; or it easily causes the device damage in the transducer. If it is necessary, please use corresponding rising and dropping equipment to make transformation disposal.
9	Change three- phase input to two- phase input	Don't change three-phase AC frequency vector inverters of PT 100 to two-phase for use. Or it may cause breakdown or damage the transducer.
10	Protection of lightning impulse	The AC frequency vector inverters has protection device for lightning strike and over current; and it has certain self-defensive ability for the inductive thunder. The customer should install protection device before the AC frequency vector inverters at frequent occurrence of the lightning.
11	Use of altitude and derating	It is necessary to use it via derating in the region where the altitude is above 1000m due to the weakening cooling effect of the AC frequency vector inverters caused by thin air. Please make a technology consulting to our company for such a condition.
12	Some special usages	Please consult our company if it is necessary for the customer to use the connection method beyond the suggestions provided in this manual, like DC bus.
13	Attention for the abandonment types of AC frequency vector inverters	It may cause explosion when the electrolytic capacitor of main circuit and printed board burn. And the burning of plastic parts will cause poisonous gas. Please dispose it as industrial refuse.

No.	Types of attention	Precautions contents
14	About adaptive motor	<p>1) Standard adaptive motor is asynchronous induction like a quadrupole squirrel cage. If it is not the above motor, please select the AC frequency vector inverters based on the rated current of the motor.</p> <p>2) Cooling fan</p> <p>3) Zx67y non-variable frequency motor and rotor spindle is connected with the same axis; cooling effect of the fan reduces when the rotate speed reduces; therefore, install powerful cooling fan or replace variable frequency motor when the motor is too hot.</p> <p>3) The AC frequency vector inverters has been installed with standard parameter of adaptive motor; it is necessary to make parameter identification or modify default value according to practical situation to correspond with the actual value; or it may affect the operation effect or protection performance.</p> <p>4) short circuit in the cable or motor will cause the alarm of the AC frequency vector inverters or even explosion of the motor, so please make a short-circuit test of insulation for the motor with initial installation; and it is necessary to make such a test in daily maintenance. Notice: make sure to completely disconnect the AC frequency vector inverters with the part required to be testing when such a test is made.</p>
15	Others	<p>1) Never connect alternating current power supply with terminals like U, V and W for output end of the transducer.</p> <p>2) The panel must be fixed and locked before electrifying in order to avoid personal injury caused by harmful components like internal</p>

No.	Types of attention	Precautions contents
		<p>capacitance.</p> <p>3) Tasks such as wiring and inspection can't be made after the power is connected.</p> <p>4) After the electrifying of this device, please don't touch its interior circuit and component to avoid electric shock hazard.</p> <p>5) Don't touch the circuit board or any component in the motor within five minutes shown on keyboard after the power is off; what is more, the meter should be used to confirm the capacitance in the motor has been discharged and then the task in the motor can be made; or it may have hazard of electric shock.</p> <p>6) Electrostatic on human body will seriously affect MOS field effect transistor; don't use your hand to touch any internal component such as printed circuit board and IGBT without anti-static precautions; or it may cause breakdown.</p> <p>7) Grounding terminal of the AC frequency vector inverters(E or ⏏) should be correctly and reliably connected to the ground based on salty requirement of national electricity and other related standards. Don't stop the motor via operating a switch or interruption of power supply; and the power can be off only after the stop of the motor operation when it is used .</p> <p>8) It must select input filter accessory if it want to meet CE standard.</p>

1-4 Range of application

- ※ This AC frequency vector inverters can be applied only to general three-phase AC induction motor of industry.
- ※ This AC frequency vector inverters can be only used

in places approved by our company; it may cause accidents like fire, electric shock and explosion in the places not approved by our company.

If it used for the equipment (e.g. Lifting appliance, aviation system and safety equipment) which may cause personal injury due to the AC frequency vector inverters failure, such an occasion must be cautiously disposed and reported to our company.

This device is only allowed to be operated by the staff with qualified training. Please carefully read the content about safety, installation, operation and maintenance in this introduction before your use. Safe operation of this device depends on the correct transportation,

Chapter 2 Standard specification

2-1 Technical specifications

2-1-1. Technical specifications of PT200

AC frequency vector inverters type	Input voltage	output rating (kW)	Rated input current (A)	Rated output current (A)	Adaptive motor
PT100-0R4G-1B	Single phase 220V ±15%	0.4	5.4	2.3	0.4
PT100-0R7G-1B		0.75	8.2	4.5	0.75
PT100-1R5G-1B		1.5	14.2	7.0	1.5
PT100-2R2G-1B		2.2	23.0	10	2.2
PT100-0R4G-2B	Three phase 220V ±15%	0.4	2.6	2.4	0.4
PT100-0R7G-2B		0.75	5.0	4.5	0.75
PT100-1R5G-2B		1.5	7.7	7	1.5
PT100-2R2G-2B		2.2	11.0	10	2.2
PT100-0R4G-3B	Three phase 380V ±15%	0.4	1.7	1.2	0.4
PT100-0R7G-3B		0.75	3.4	2.5	0.75
PT100-1R5G-3B		1.5	5.0	3.7	1.5
PT100-2R2G-3B		2.2	5.8	5	2.2

2-1-2 See the following table for rated output current with different specifications

G/P/H/S/Z/T/M						
Voltage	220V 1Φ	220V (240V)	380V (415V)	460V (440V)	575V	660V
Power (Kw)	Current (A)	Current (A)	Current (A)	Current (A)	Current (A)	Current (A)
0.4	2.5	2.5	1.2	-	-	-
0.75	4.5	4.5	2.5	2.5	-	-
1.5	7	7	3.7	3.7	-	-
2.2	10	10	5	5	-	-

2-2 Standard specification

Item		Standard
Power supply	Level of voltage frequency	Single phase 200~240V, 50/60Hz three phase 200~240V, 50/60Hz three phase 380~415V, 50/60Hz
	Allowable fluctuation	Voltage :±15% frequency: ±5%
Control performance	Control system	AC frequency vector inverters based on the high performance of DSP
	Output frequency	G/P/Z/S/T/M type: 0.00~400.0Hz, The highest frequency can be set among 10.00~400.0Hz
	Control method	V/F control, vector control for flux with open loop 1, vector control for flux with open loop 2,
	Lifting function of automatic torque	Torque control for low frequency (1Hz) and great output in the control method of V/F
	Control on accelerating and decelerating	Setting method for subsections of accelerating and decelerating S curve; the longest operation time 9600 h

Item		Standard
	Control on program operation	Operation for speed program of 16 sections; the longest operation time 888.88 h
	Image resolution of frequency setting	Figure: 0.01Hz(below300Hz), 0.1Hz(above300Hz) simulation: 0.05Hz / 60Hz
	Frequency accuracy	Common difference of speed control 0.01%(25°C \pm 0°C)
	V/F curve method	User defines V/F curve for linear and multiple power
	Overload capacity	G/S type: rated current 150%—1 minute, rated current 200%—0.1 second P type :rated current 120%—1 minute, rated current 150%—0.1 second
	Slippage compensation	50~100%, compensation for automatic slippage
	The highest frequency	400Hz
	Carrier frequency	0.5KHz~15KHz; carrier frequency can be adjusted based on the load characteristics
	Image resolution of output frequency	Figure setting: 0.01Hz simulation setting: the highest frequency \times 0.1%
	Starting torque	G motor: 0.5Hz/180%
	Speed range	1:200

Item	Standard
Accuracy of speed stabilizing (accuracy of speed control)	Vector control for flux with open loop: $\leq \pm 0.5\%$ (rated synchronous speed)
Stability of speed control	vector control for flux with open loop : $\leq \pm 0.3\%$ (rated synchronous speed)
Torque response	$\leq 40\text{ms}$ (vector control for flux with open loop)
Torque boost	Automatic torque boost; manual torque boost 0.1% ~ 30.0%
acceleration and deceleration line	Acceleration and deceleration method for line; for acceleration and deceleration time; time scope for acceleration and deceleration 0.0s ~ 3600.0s
DC braking	DC braking frequency : 0.0Hz ~ maximum frequency, braking time: 0.0 ~ 36.0 second, current value for braking movement: 0.0% ~ 100.0%
Electronic control	Range of jog frequency : 0.00Hz ~ maximum frequency; Acceleration and deceleration time of jog: 0.0s ~ 3600.0s
Operation on multi sections	Realize the maximum operation of 16 sections via control terminals
Build-in PID	Realize closed-loop control system with process control conveniently:
Automatic voltage regulation (AVR)	Automatically make the output voltage constant when the network voltage changes
Torque limitation	Excavator characteristics: automatic limitation on torque during the

Item		Standard	
	and control	operation period and prevention for frequent overcurrent trip; and vector model of close loop can realize the torque control	
Personalized function	Self-checking for outside equipment safety of electrifying	Realize the security detection of electrifying on outside device like ground connection and short circuit	
	Function of DC bus	Realize the function for many inverter to share DC bus	
	 key	Programmable key: function choice for positive and negative operation and jog operation	
	Pendulous control of textile	Multi control functions of triangular wave	
	Current -limiting function of the carrier	Built- in current-limiting algorithm of waveband reduces the probability for the AC frequency vector inverters to report overcurrent and improve the whole motor's ability on resisting disturbance	
	Timing control	Timing control function: setting time scope 0h~65535h	
	Standardization for extension cord of the keyboard	The customer can use the standard network cable to prolong the keyboard	
Operation	Inputting signal	Operation method	Keyboard/terminal/communication
		Frequency setting	Six frequency source in total: setting of keyboard, analogue voltage, analogue current, operation for multiple sections, PID control, remote

Item		Standard	
		communication and presetting of keyboard potentiometer can be changed via multiple methods	
		Starting signal	Forward and Reverse
		Speed of multiple sections	Speed for 16 sections can be set at most (using multifunction terminal or program execution)
		Acceleration of multiple sections	Acceleration 4 sections can be set at most (using multifunction terminal)
		Emergency stop	Interrupt controller output
		Operation of pendulous frequency	Operation of process control
		Jog	Operation with low speed
		Fault resetting	Automatically or manually reset the fault state when the protection function is at an effective state
		PID feedback signal	Including DC 0~10V, DC 1~5V, DC 0~20mA and DC 4~20mA
Outputting signal	Operating condition	Motor situation showing stop, acceleration and deceleration, constant speed and state of programme operation	
	Fault output	Output of sensitive point-AC 250V 5A, DC 30V 5A	
	Analog output	one analog outputs can choose 8 signals such as frequency, current, voltage and so on; and output signal scope can be set randomly among	

Item		Standard
		0~10V/0~20mA.
	Output of digital quantity	one output signals; every output signal has nine signals for choice
	Operation function	Limiting frequency, avoiding frequency, slippage compensation, invert protection, self-adjusting and PID control
	Braking of direct current	Built-in PID adjusts brake current and protects sufficient braking torque without overcurrent
	Run command channel	Three channels: presetting of operation panel, control terminal and serial communication. The change via various methods
	Input terminal	Six digital input terminals can be compatible with active loudspeaker PNP or two input terminals of analog of NPN input method; among them, AI1 and AI2 can be input as voltage or current. (if it necessary to expand the function of input and output terminals, please use IO expansion cards)
	Output terminal	One digital output terminal (bipolar output), a relay output terminal, and an analog output terminal can respectively choose 0/4mA~20mA or 0/2V~10V and realize the output of physical quantities such as setting frequency, output frequency and rotate speed
Protection function	AC frequency vector inverters protection	Overvoltage protection, low-voltage protection, overcurrent protection, overload protection, overheat protection, protection of overcurrent

Item		Standard
		and speed reduction, protection of overvoltage and speed reduction, protection of default phase (optional functions), external fault, communication error, abnormal feedback signal of PID and PG fault
	IGBT temperature display	Display current IGBT temperature
	Control of AC frequency vector inverters fan	Starting temperature for the fan can be set
	Instant power failure and then restarting	Less than 15 millisecond: Continuous operation More than 15 millisecond: automatically detect the motor speed and restart after instant power failure
	Tracking method of rotate speed	Automatically track motor speed at the start of the transducer
	Protection function of parameter	Protect the AC frequency vector inverters parameter via setting supervisor password and decode
Display	LED /OLE D show keyboard	Operation information
		18 monitoring objects of the operation in total: operation frequency, setting frequency, rated current of the motor, current percentage, DV bus voltage, output voltage, actual speed of the motor, accumulative operation time, IGBT temperature, PID given value, feedback value of PID, state of input terminal, state of output terminal, value of analog AI1, value of analog AI2A, current number for speed of multiple sections and setting value of torque

Item		Standard
	Error message	Keep five error messages at most and inquire fault type, voltage, current, frequency and working condition when the fault occurs
	LED display	Display parameter
	OLED display	Options available; instruction in Chinese/English
	Parameter copy	Using special keyboard of parameter copy can realize the quick copy of the parameter (limited too OLED)
	Key lock and function choice	Realize partial or complete lock of the button; define the effect scope of partial buttons to prevent wrong operation
Communication	RS485/RS232	It can choose isolated RS485/RS232 communication module to realize the communication with the upper computer
Environment	Environment temperature	-10°C~40°C(environment temperature is among 40°C~50°C; please use it with derating)
	Storage temperature	-20°C~65°C
	Environment humidity	Less than 90 % R.H, not exceeding 90 % R.H
	Height; vibration	Below 1000 m, below 5.9m/s ² (=0.6g)
	Application place	Indoor, without sunlight or corrosivity, explosive gas or water vapor, dust, combustible gas, oil mist, water vapor, dropping water or salinity
	Altitude	Belong 1000m
	Pollution degree	2

Item		Standard
Product standard	The product implements safety standard	IEC61800-5-1:2007
	The product implements EMC standard	IEC61800-3:2004+A1:2011
Cooling method		Forced cooling and natural air cooling

2-3. Dimension

2-3-1 outline drawing of the product and dimension of installing hole

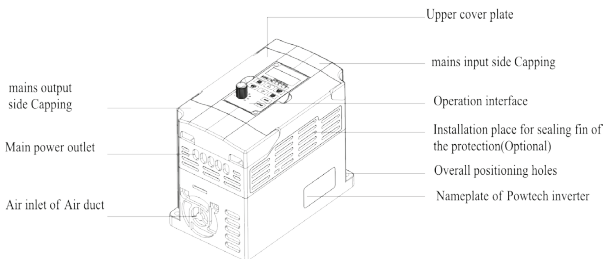

Chart 2-2 Product Outline Drawing

2-3-2 PT100 series

1.1S2

1) 2S1

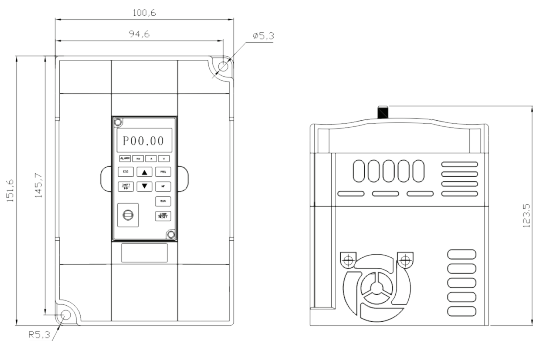
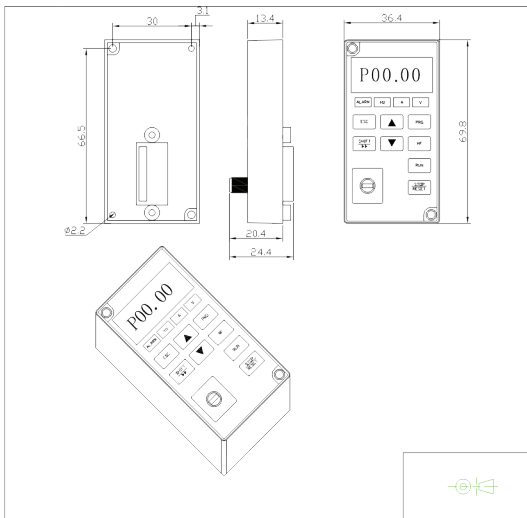

Chart 2-2 Dimension of 2S1

Level of power supply	Type	Power (kW)
Single phase 220V	G	0.4~2.2
	M	0.4~2.2
Three phase 220V	P	0.4~2.2
	G	0.4~2.2
Three phase 380V	P	0.4~2.2
	G	0.4~2.2

2-3-3. Dimension figure of keyboard

JP6C100 dimension figure:



JP6D100 dimension figure of keyboard cabin:

Chart 2-3 JP6D100 dimension

Chapter 3 Installation and redundant circuit

3-1 Service environment

- (1) Environment temperature $-10^{\circ}\text{C}\sim 40^{\circ}\text{C}$;
- (2) Prevent electromagnetic interference and be far away from interference source.
- (3) Prevent the invasion of water drop, vapor, dust, dirt, cotton fiber and lemel.
- (4) Prevent the invasion of oil, salt and corrosive gas.
- (5) Avoid vibration.
- (6) Avoid high temperature and humidity and there is drench from the rain; and the humidity is smaller than 90%RH (without condensation).
- (7) Prohibit being used in environment with inflammable, combustibile and explosive air, liquid or solid.

3-2 Installation direction and room

Variable-frequency inverter should be installed at a indoor place with good ventilation and used the wall-mounted method; moreover, there must be enough room

between it and its surrounding article or baffle (wall). It is shown as the following chart.

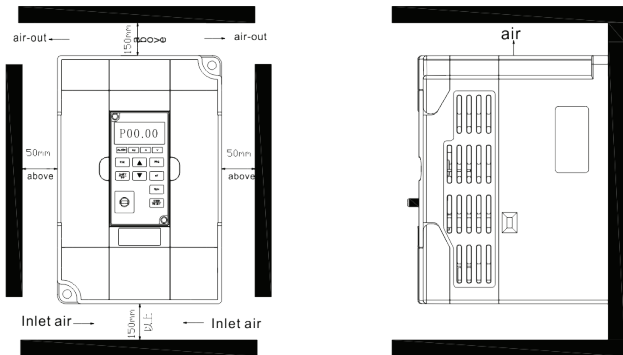

Chart 3-1 installation direction and room

3-3 Wiring diagram

Wiring of variable-frequency inverter divides into main circuit and control loop. The user must make the connection correctly following the below wiring circuit.

3-3-1 Wiring diagram below 2.2KW (1S2)

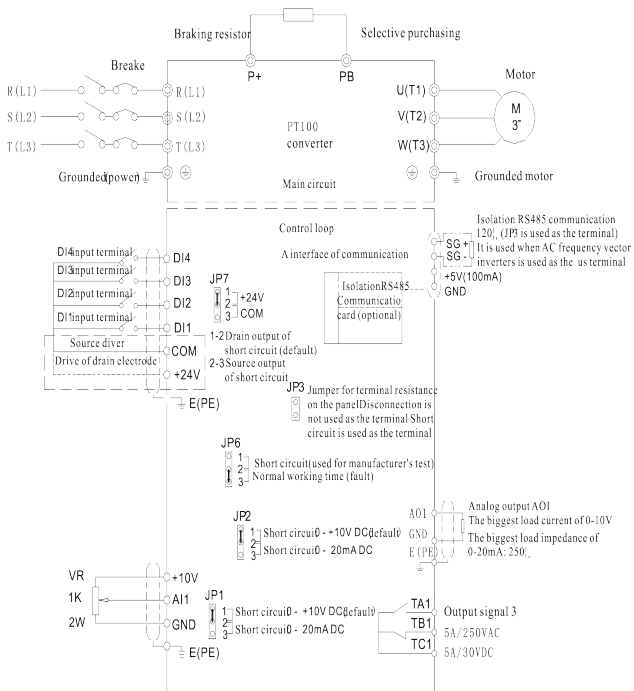

Chart 3-2 Wiring diagram below 2.2KW

3-4. Main circuit terminal (G type)

3-4-1. Main circuit terminal of PT100

1. Main circuit terminal below 2.2KW (220V)

The main power input

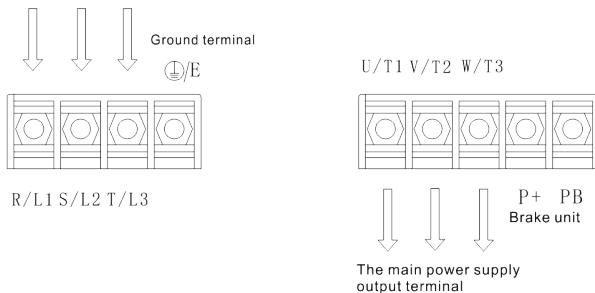

Chart 3-3 Main Circuit Terminals below 2.2KW (220V)

3-4-2 Explanation for the function of terminal blocks

Terminal	Name	Explanation
R/L1	Input terminal of AC frequency vector inverters	Connect with three-phase power supply and connect single phase with R and T
S/L2		
T/L3		
⊕/E	Ground terminal	Connect with the ground
U/T1	Output terminal	Connect with three-phase motor
V/T2		
W/T3		

P+, PB/⊖	Connecting end for brake resistance or brake unit	Connect with brake resistance or brake unit
----------	---	---

3-5 Control circuit terminal

3-5-1. Explanation for control circuit terminal

Classification	Terminal	Name	function
Input signal	DI1 ~ DI4	DI1 ~ DI4 input terminal	See function P06.00 ~ P06.03 for the detail of input terminal with multiple functions. PLC controls the driving form of DI.
Supplementary power supply	+24V	Plus end of power supply	The biggest output is +24V/200mA; never make a short circuit between COM and GND under any condition
	COM	Common terminal	
	TA1/TB1/TC1	Common terminal	TA1 → TC1 normally open, TB1 → TC1 normally close; and output function is set by P08.00.
Input and output signal of analog	+10V → GND	Simulated power supply	Provide +10V power supply externally; and the biggest output current: 10mA It is generally used as external potentiometer; and scope for resistance value of potentiometer is 1K.

	AI1	Simulated input signal with multiple functions 1	Short circuit for JP1 1-2: it can be adjusted among 0-+10V. Short circuit for JP1 2-3: it can be adjusted among 0-+20mA. P06.07-P06.10 sets the scope of input voltage or current.
	AO1	Simulated output signal with multiple functions 1	Short circuit for JP2 1-2: 0-+10V。 Short circuit for JP2 2-3: 0-+20mA。 P08.01 sets the setting for analog output. P08.02-P08.05 sets the scope of output signal

3-5-2. Arrangement of control circuit terminal

1. Control circuit terminal of 100SCB panel

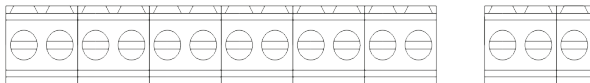

AI1 AO1 10V GND 485+485- DI1 DI2 DI3 DI4 +24V COM

TB1 TA1 TC1

Chart 3-4 Control circuit terminal board 100SCB

3-6 Wiring precautions

- ※ Don't install absorption apparatus of static capacitance or resistance capacitance at the U, V and W output terminal of the transducer. The input

power supply of the AC frequency vector inverters must be off when the motor is changed.

- ※ Don't drop the metal chip or thread residue into the AC frequency vector inverters when the wiring is made, or the AC frequency vector inverters may have fault due to this.
- ※ The motor or power supply of power frequency can be changed only after the AC frequency vector inverters stops outputting.
- ※ It should consider installing absorption apparatus of surging when the electromagnetic contactor and relay is near to the AC frequency vector inverters in order to reduce the influence of the electromagnetic interference.
- ※ External control line of the AC frequency vector inverters must have isolating device or adopt shielded wire.
- ※ Cable for signal of input order should have independent routing beside shieldling; and it is better to be far away main circuit wiring.
- ※ The maximal distance between the AC frequency vector inverters and motor should be within 50m when the carrier frequency is smaller than 3KHz; and such a distance should be shortened when the carrier frequency is bigger than 4KHz; and it is better for this wiring to be laid in metal pipe.
- ※ When peripheral equipment (filter, electric reactor) is installed on the transducer, it should firstly

use 1000 V megameter to measure its insulation resistance to the ground and it should be guaranteed it is no less than megohm.

- ※ Please don't close the power supply under the condition of frequent start of the transducer; control terminal or keyboard or RS 485 must be used to operate the order to make start-stop operation so that it can't destroy the rectifier bridge.
- ※ Don't connect AC input power with output terminals of transducer: U, V and W.
- ※ In order to avoid the accident, ground terminal (\perp) must be connected to the ground reliably (ground impedance should be less than Ω), or leakage will appear.
- ※ Choice for specification of wiring diameter should be according to related stipulation of National Electric Code when main circuit wiring is made.
- ※ Electric motor capacity should be equal to or less than the capacity of the transducer.

3-7 Redundant circuit

It will cause serious halt loss or other sudden failures due to the fault or tripping of the transducer. In order to avoid such a condition appears, please increase the following circuit backup for the sake of safety.

Notice: redundant circuit should be confirmed in

advance and its operation feature should be tested in advance to guarantee the consistence between phase sequence of power frequency and variable frequency.

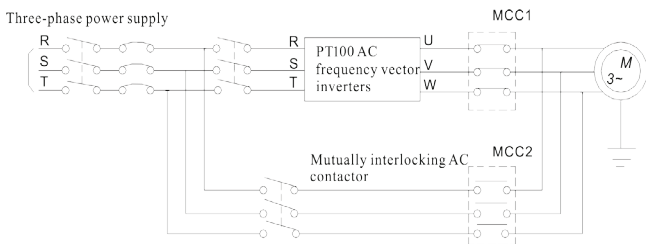

Chart 3-4 Standby circuit

Chapter 4 Operation keyboard

4-1. Introduction of operation keyboard







JP6E100 Keyboard control panel
Chart 4-1 Display of operation panel





4-2. Introduction for indicator light of the keyboard

Sign of indicator light		Name	Unit display	Implication	color
indicator light of unit combination	ALARM	Alarm light		Bright: the AC frequency vector inverters has fault Off :the AC frequency vector inverters has no fault Flicker: previous fault of the AC frequency vector inverters hasn't been confirmed	Red
	Hz	Frequency light	Hz	Bright: current display parameter is operation frequency Flicker: current display parameter is setting frequency	Green
indicator light of unit combination	A	Current indicator light	A	Bright: current display parameter is current	Green
	V	Voltage indicator light	V	Bright current display parameter is voltage	Green
	Hz+A	Percentage indicator light	%	Bright :current display parameter is percentage	Green
	A+V	User-defined indicator light	s	Bright/flicker: current display parameter is user-defined parameter	Green
	Hz+V	Temperature indicator light	°C	Bright: current display parameter is temperature	Green

	Hz+ A+V	Time indicator light	RP M	Bright :current display parameter is RPM	Green
		indicator light without unit		Off :current display parameter has no unit	Green

4-3. Key description of operation panel

Sign	Name	Function
	Parameter setting/Escape key	* Exit the data modification of function item * Return to state display menu via submenu or function menu
	Shift key	* Under third level menu, use  to move data edit bit of function code * Under stop / operation state, recurrently select display parameter to make state of stop run, display inquiry (see P07.05- P07.06 for refer meaning of display)
	Forward Operation Key / Reverse Operation Key	* Inch runs of inverter *Switch between forward and reverse rotation of inverter *Inverter eliminate setting of increasing+ of clockwise rotation / decreasing- of counter clockwise rotation
	Confirm Key of the data	* Enter menu screen each level and confirm setting of parameter

	Operation key	* Use for operation under the method of keyboard operation
	Stop / Reset Key	* Actuator stops operation * Abnormal reset * Fault confirmation
	UP	* Under the first-level menu, increasing of function code P00-P15 * Under the second-level menu, increasing for labeling of function code * Under the third-level menu, increasing for data of function code * Under stopping/operating state, increasing for frequency presetting or presetting of closed loop
	DOWN	*Under the first-level menu, decreasing of function code P00-P15 - Under the second-level menu, increasing for labeling of function code * Under the third-level menu, decreasing for data of function code *Under stopping/operating state, decreasing for frequency presetting or presetting of closed loop

4-4. Menu style

Menu display adopts three-level menu style and they are shown as following respectively:

- 1) Group number of function code(first-level menu)
- 2) Label of function code(secondary menu)
- 3) Set value of function code (three-level menu)

4-4-1. First-level menu style

● Structure of first-level menu

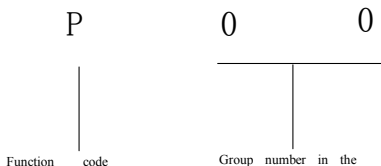

Chart4-2 Structure of first-level menu

● Instruction for area of first-level menu

Active area of password	Area of function code	Group number in the area	Scope of function code
Protection area of user password P00-P14	User's operation area(P00-P14)	P00 group	P00.00~P00.18
		P01 group	P01.00~P01.16
		P02 group	P02.00~P02.12
		P03 group	P03.00~P03.11
		P04 group	P04.00~P04.07
		P05 group	P05.00~P05.15
		P06 group	P06.00~P06.18
		P07 group	P07.00~P07.14
		P08 group	P08.00~P08.12
		P09 group	P09.00~P09.21

		P10 group	P10.00~P10.10
		P11 group	P11.00~P11.50
		P12 group	P12.00~P12.06
		P13 group	P13.00~P13.10
		P14 group	P14.00~P14.08
Protection area of manufacturer's password	Obvious-hidden area of user defined function code (P15 area)	P15 group	P15.00

4-4-2. Form of secondary menu

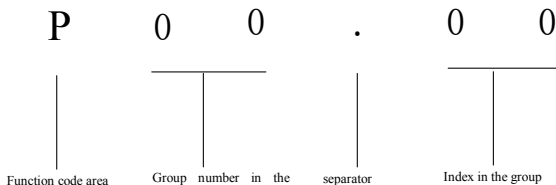

Chart4-3 Form of secondary menu

●Data display or setting form of secondary menu

Decimal display/setting:

Sign can be displayed or set by data bits 1~5 is 0-9.

4-4-3. Form of three-level menu

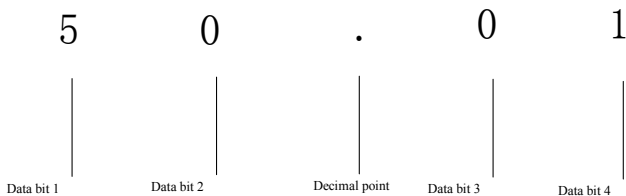

Chart4-4 Form of three-level menu

4-4-4. Common display symbol of LED

Besides function code, the first-level menu, secondary menu and three-level menu, the operation panel will show some prompting character; and see following table for detail:

Prompt	Implication	Prompt	Implication
PT100	The AC frequency vector inverters instantly show PT200 to represent PT200 product after electrifying	E.PHI	Default phase at the input side
E.oUP	U-phase protection of contravariant unit	E.PHo	Default phase at the output side
E.oUP	V-phase protection of contravariant unit	E.oH1	Overheating of rectifier module
E.oUP	W-phase protection of contravariant unit	E.oH2	Overheating of contravariant module

E.oC1	Overcurrent of acceleration	E.SET	External fault
E.oC2	Overcurrent of deceleration	E.CE	Communication fault
E.oC3	Overcurrent of constant speed	E.ItE	Fault of current detection
E.oU1	Overvoltage of acceleration	E.tE	Fault for self-study of motor
E.oU2	Overvoltage of deceleration	E.EEP	Operation fault of EEPROM
E.oU3	Overcurrent of constant speed	E.PId	Break-line fault for feedback of PID
E.LU	Undervoltage fault of generatrix	E.bCE	Brake unit fault
E.oL1	Motor overload	END	Retaining
E.oL2	AC frequency vector inverters overload	0.0.0.0.0	Protection of user password

Notice: the menu specially shows the implication of 0.0.0.0.0

If the starting shows five points beside the data, it means it has password protection. The function code which can make password input is P15 which is retention parameter area of manufacturer and P07 is the setting area of user password.

Please contact with the local agency or the manufacturer when prompt which is not listed in the above table is met.

4-4-5.LED displays corresponding sign

Correspondence between the sign showed by LED and character or number is as following:

Letter displayed	Corresponding letter	Letter displayed	Corresponding letter	Letter displayed	Corresponding letter
0	0	1	1	2	2
3	3	4	4	5	5
6	6	7	7	8	8
9	9	A	A	b	B
C	C	d	d	E	E
F	F	H	H	I	I
L	L	N	N	n	N
o	o	P	P	r	R
S	S	t	t	U	U
u	v	T	T	-	-

4-5. Password operation and key

- Set password: enter into function code of password
- Verify password:

Enter into function code of password and the parameter in the password protection can be seen via inputting the password once; please refers to instruction of the password.

★ Clear password:



After successively inputting verification password, directly enter into the menu or enter into the menu via



enter into the function code of password to set 00000; after successfully clearing the password, it is unnecessary to input password for verification when the password protection area is entered.

★ Effective method of password protection:

Two of the following methods can be chosen randomly:

1. Press  +  at the same time;
2. There is no key operation for successive five minutes;
3. Electrify again.

● Key lock and unlock

1. Key lock: it can be locked by pressing



+



at the same time.

2. Key unlock: it can be unlocked by pressing

+









At the same time



4-6. Display of operation panel and key operation

4-6-1. Classification of display state: display state of operation panel can be divided into 9 types:

No.	State name	Implication
1	Display state for the stop parameter	Display parameter can be changed via  and P07.06 can set display parameter
2	Display state for the operation parameter	Display parameter can be changed via  and P07.05 can set display parameter
3	Display state for the fault and alarm	Directly enter into this state when the fault occurs under other seven display states
4	Display state for the first-level menu	Press  when the key is unlocked
5	Edit status of secondary menu	Press  to enter under the display state of the first-level menu
6	Edit status of three-level menu	Press  to enter under the display state of the secondary menu

7	State of password authentication	Press  to enter under the display state of the first-level menu when it has password protection
8	Modification state of direct parameter	Under display of the stop and parameter, press the shuttle key to enter via left rotation and right rotation
9	State of information cue	Refer to 4-4-5 LED displays corresponding sign

4-6-2. Display status and of operation process

Under the three-level menu and the state of password authentication,  is used for the bit choice of the data editing.

- Automatic switch of the state

It automatically returns to the display state of the stop parameter or operation parameter without key operation for one minute.

After removing the editing state of the menu, it returns to the display state of the stop parameter or operation parameter without key operation for one minute.

If it has the password setting or lock device of the key, it will automatically returns to the password protection and lock state of the operation panel without the key operation for 5 minutes.

● Display state and operation process

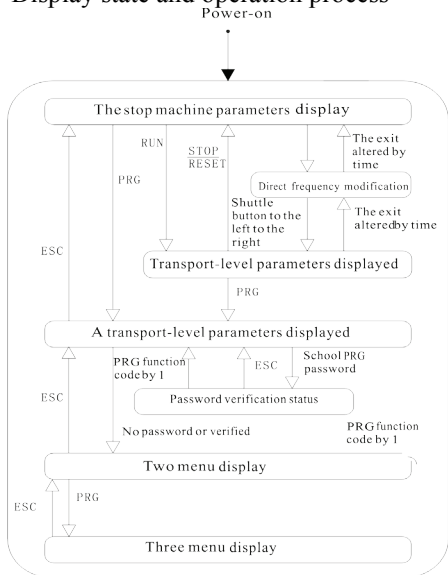

Chart 4-5 Status display and operational processes

Chapter 5 Commissioning

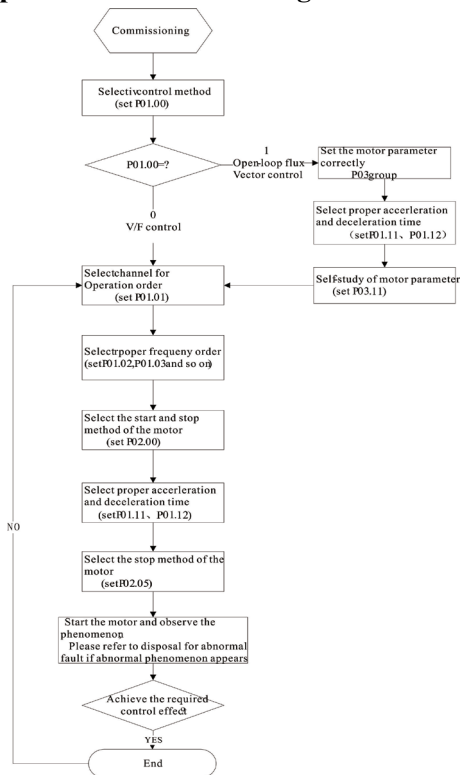

Chart 5-1 Commissioning

- Before Connect the power supply with the variable-frequency inverter, please firstly confirm the voltage of AC input power is within the scope of rated input voltage of variable-frequency inverter.
- Connect the power supply with the input terminal R, S and T of variable-frequency inverter.
- Select proper control method of rotation.

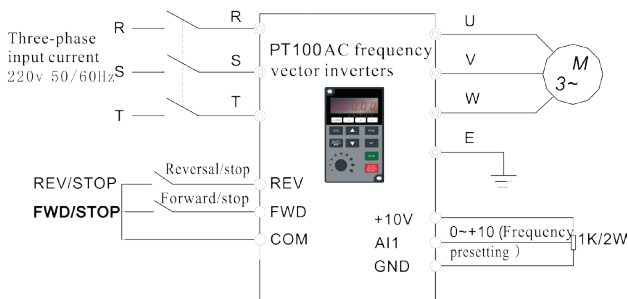



Chart 5-2 control method of rotation

Example: voltage input of analog (P01.00=1, P01.03=1 or 2)+ control operation of the terminal (P06.01=1、P06.02=2) ;

Frequency order is given by terminal AI1/AI2 and terminal DI2 and DI3 control forward and reversal rotation.

Example: speed regulation of keyboard(P01.01=0,

P01.03=0)+ reward and reversal switch operation of the keyboard (P07.03=1)

The frequency is preset by the increase of clockwise rotation and the decrease of counterclockwise rotation of the keyboard  ; operation keyboard  change the forward and reversal rotation.

- ※ Empty running and check of speed regulation.
- ※ Confirm the set of the lowest and highest output frequency.
- ※ Inspection of inching control.
- ※ Affirm the acceleration and deceleration time.
- ※ Connect up the motor.
- ※ Operate with low speed and inspect the rotation direction of the motor.
- ※ Inspect whether the display and output during all operation processes is correct.

Chapter 6 Instruction of function parameter

6-1. List of function parameter

Function of PT100 series AC frequency vector inverters can be divided into 15 groups, namely P01~P15 according to the function; and every function group includes several function codes. The function code adopts three-level menu; for example, P08.08 means the eighth function code in P08 function group ; and P15 is the manufacturer's function parameter and the user has no right to visit the parameter in this group.

In order to make convenience for the setting of function code, group number of the function, number of function code and parameter of function code respectively corresponds with the first-level menu, the secondary menu and three-level menu when the operation panel is used for operation.

1. Instruction for the content in the line of menu is as following:

NUMBER in the first line: it is the serial number for this function code in the whole function code; meanwhile, it also shows the register address for the communication.

CODE in the second line: it is the serial number for the parameter group of the function and parameter.

DESCRIBING LED/OLED KEYBOARD DISPLAY in the third line: it is the detailed description of this function parameter.

SETTING RANGE in the fourth line: it is the

effective setting range of the function parameter and it is shown on OLED liquid crystal screen of the operation panel.

FACTORY SETTING in the fifth line: it is the original set value for the function parameter when it leaves the factory;

ALTERATION in the sixth line: it is the alternative attributive of the function parameter (i.e. whether it allows alternation and alternating condition); and the instruction is as follow:

“◇” shows the set value of the parameter can be alternated whenever the AC frequency vector inverters is stopped or operated;

“□” shows the set value of the parameter can't be alternated when the AC frequency vector inverters operated;

“■” shows the value of the parameter is actual record value of the detection; and it can't be changed;

(the AC frequency vector inverters has made an automatic check and restriction on alternative attributive of every parameter and it can help the user to avoid wrong alternation.)

2. Parameter system is decimal system; if the parameter is shown via hexadecimal, every data is independent mutually when the parameter is edited; value range of partial bits can be hexadecimal (0~F).

3. Factory setting shows the value after the parameter of the function code is updated when the

operation of recovering factory parameter; parameter or record value of actual detection can't be updated.

4. In order to protect the parameter more effectively, the AC frequency vector inverters provides password protection for the function code. After the user password (namely, parameter for user password P07.00 is not 0) is set, the system will firstly enter into the state of user password authentication when the user press to enter into the editing state of the function code; and then what is shown is 0.0.0.0.0.; the operator must input user password correctly, or the user can't enter. It is unnecessary to input manufacturer's password correctly for the parameter zone set the manufacturer. (warning: the user can't try to change the parameter set by the manufacturer; if the parameter is not set properly, it will easily cause the abnormal work or even destroy of the AC frequency vector inverters). The user password can be changed randomly under the condition that the password protection is unlocked; the user password is subject to the value input last. Setting P07.00 to 0 can cancel the user password; if P07.00 is not 0 when electrify, then it shows the parameter is protected by password.



5. Function of user password also follows the above principle when the serial communication is used to change the parameter of the function code.

6-1-1.Menu grouping

Code	Describing LED/OLED Keyboard display	Function description	Amount
P00	Monitoring function group	Monitor frequency, current and so on; 18 monitoring objects	19
P01	Basic function group	Frequency set, control method, acceleration and deceleration time and so on	17
P02	Control group of start and stop	Parameter control of the start and stop	13
P03	parameter group of electrical machine	Set of electrical machine parameter	12
P04	Parameter of vector control	Parameter of vector control	8
P05	V/F controls parameter	User defined	16
P06	Input terminal group	Analog and digital input function	19
P07	Human-computer interface group	Parameter set of user menu	15
P08	Output terminal group	Analog and digital input function	6

Code	Describing LED/OLED Keyboard display	Function description	Amount
P09	Enhancement group	Acceleration and deceleration and jog of pendulous frequency	22
P10	PID control group	Set of built-in PID parameter	11
P11	Control group of multiple speed	Set of multiple speed and PLC operation	16
P12	Communication interface group	Set for communication function of MODBUS	7
P13	Protection parameter group	Set of protection parameter	11
P14	Function group of water supply	Set for the parameter of constant pressure water supply	5
P15	Manufacturer's function group	Set of manufacturer's parameter	1

6-1-2. P00 group Monitoring function group

No.	Code	Describing LED/OLED Keyboard display	Setting range	Factory setting	Change
1	P00.00	Operation frequency	Currently actual output frequency of the AC frequency vector inverters	HZ	■
2	P00.01	Set the frequency	Currently actual constant frequency of the transducer	HZ	■
3	P00.02	DC bus voltage	Estimated value of DC bus voltage	V	■
4	P00.03	Output voltage of AC frequency vector inverters	Actual output voltage of transducer	V	■
5	P00.04	Output current of transducer	Actual output current of transducer	A	■
6	P00.05	Actual rotate speed of the motor	Actual running speed of the motor	RPM	■
7	P00.06	Output power of the AC frequency vector inverters	Percentage for actual output power of the AC frequency vector inverters	%	■
8	P00.07	Output torque of the transducer	Actual output torque of the transducer	N*m	■

No.	Code	Describing LED/OLED Keyboard display	Setting range	Factory setting	Change
9	P00.08	Given value of PID	Percentage for the given value of PID adjusts the operation	%	■
10	P00.09	Feedback value of PID	Percentage for the feedback value of PID adjusts the operation	%	■
11	P00.10	State of input terminal	State of input terminal	-	■
12	P00.11	State of output terminal	State of output terminal	-	■
13	P00.12	Value of analog AI1	Value of analog AI1	V	■
14	P00.13	Value of analog AI2	Value of analog AI2	V	■
15	P00.14	Current section of multiple speed	Current section of multiple speed	-	■
16	P00.15	Temperature of rectifier module	0~100.0°C	°C	■
17	P00.16	Temperature of contravariant module	0~100.0°C	°C	■
18	P00.17	Software version		-	■

No.	Code	Describing LED/OLED Keyboard display	Setting range	Factory setting	Change
19	P00.18	Total operation time of this machine	0~65535h	0	■

6-1-3. P01 group Basic group

No.	Code	Describing LED/OLED Keyboard display	Setting range	Factory setting	Change
20	P01.00	Control mode	0:V/F control 1: vector control for open-loop flux 1 2: vector control for open-loop flux 2	0	□
21	P01.01	Operation instruction channel	0: Instruction channel of keyboard (LED goes out) 1: Instruction channel of terminal (LED flicks) 2: Instruction channel of communication (LED lightens)	0	□

No.	Code	Describing LED/OLED Keyboard display	Setting range	Factory setting	Change
22	P01.02	Increasing + or decreasing of decoder and terminal-set	0: valid; moreover, the AC frequency vector inverters saves without power supply 1: valid; moreover, the AC frequency vector inverters doesn't save without power supply 2: increasing+/decreasing-invalid setting 3: Setting is valid for the operation; reset when the machine stops	0	◇
23	P01.03	Selection of frequency instruction	0: Keyboard setting 1: Setting of analog AI1 2: Setting of analog AI2 3: $K1 \cdot AI1 + K2 \cdot AI2$ 4: Setting for operation of multiple speed 5: Setting of PID control 6: Setting of remote communication	2	◇

No.	Code	Describing LED/OLED Keyboard display	Setting range	Factory setting	Change
24	P01.04	Selection for the setting of torque	0: Keyboard sets torque (corresponding with P01.05) 1: analog AI1 sets torque (totally corresponds with two times as the rated current of the transducer) 2: analog AI2 sets torque (be the same as 1) 3 analog AI1+AI2 sets torque (be the same as 1) 4: setting of multi torques (be the same as 1) 5 Remote communication sets torque (be the same as 1)	0	◇
25	P01.05	Keyboard sets the torque	-200.0%~200.0%(rated current of the transducer)	50.0%	◇
26	P01.06	Choice for the setting source of upper limiting frequency	0: Keyboard sets upper limiting frequency (P01.07) 1: Analog AI1 sets upper limiting frequency (totally corresponds with maximum frequency) 2: Analog AI2 sets upper limiting frequency (be the same as 1) 3: Multi sections set upper limiting frequency (be the same as 1) 4: Remote communication sets upper limiting frequency (be the same as 1)	0	◇
27	P01.07	Maximum output frequency	10.00~400.00Hz	50.00 Hz	□

No.	Code	Describing LED/OLED Keyboard display	Setting range	Factory setting	Change
28	P01.08	Upper-frequency limit	P01.09~P01.07 (maximum frequency)	50.00Hz	◇
29	P01.09	Lower-frequency limit	0.00Hz~P01.08(Upper-frequency limit)	0.00Hz	◇
30	P01.10	Keyboard sets the frequency	0.00 Hz~P01.08(maximum frequency)	50.00Hz	◇
31	P01.11	Acceleration time1	0.1~3600.0s	Type setting	◇
32	P01.12	Deceleration time1	0.1~3600.0s	Type setting	◇
33	P01.13	Choice of operation direction	0: Operate towards defaulted direction 1: Operate towards opposite direction 2: Prohibit reversal operation	0	□
34	P01.14	Setting of carrier frequency	0.5~15.0kHz	Type setting	◇
35	P01.15	Recovery of function parameter	0: No operation 1: Recover default value beside the group of electric machine parameter 2: Recover default value including the group of electric machine parameter 3: Eliminate fault files	0	□

No.	Code	Describing LED/OLED Keyboard display	Setting range	Factory setting	Change
36	P01.16	Choice of AVR function	0: Invalid 1: The whole process is effective 2: It is invalid only for deceleration	2	◇

6-1-4. P02 group Control group for the stop and start

No.	Code	Describing LED/OLED Keyboard display	Setting range	Factory setting	Change
37	P02.00	Start operation mode	0: direct start 1: firstly DC brake and then start 2: firstly tracking of rotate speed and the start	0	□
38	P02.01	Launch the start frequency	0.00~10.00Hz	0.50Hz	◇
39	P02.02	Start the holding time of frequency	0.0~50.0s	0.0s	◇
40	P02.03	Start the front brake current	0.0~150.0%	0.0%	◇
41	P02.04	Start the front brake time	0.0~50.0s	0.0s	◇

No.	Code	Describing LED/OLED Keyboard display	Setting range	Factory setting	Change
42	P02.05	Selection of halt mode	0: slow down and stop 1: Random parking	0	◇
43	P02.06	Start frequency for the halt brake	0.00~P01.07 (maximal frequency)	0.00Hz	◇
44	P02.07	Waiting time of halt brake	0.0~50.0s	0.0s	◇
45	P02.08	DC brake current of halt	0.0~150.0%	0.0%	◇
46	P02.09	DC brake time of halt	0.0~50.0s	0.0s	◇
47	P02.10	Forward and reversal dead time	0.0~3600.0s	0.0s	◇
48	P02.11	Selection for the protection of terminal with electricity	0: Run command of the terminal is invalid when it is electrified 1: Run command of the terminal is valid when it is electrified	0	◇
49	P02.12	Reservation			◇

6-1-5. P03 group: Group of electric machine

parameter

No.	Code	Describing LED/OLED Keyboard display	Setting range	Factory setting	Change
50	P03.00	AC frequency vector inverters type	0:G type (load type of constant torque) 1:P type (load type of fan and pump)	Type setting	□
51	P03.01	Rated power of motor	0.4~900.0KW	Type setting	□
52	P03.02	Rated frequency of motor	0.01Hz~P01.07 (maximum frequency)	50.00Hz	□
53	P03.03	Rated rotate torque of motor	0~36000rPm	Type setting	□
54	P03.04	Rated voltage of motor	0~460V	Type setting	□
55	P03.05	Rated current of motor	0.1~2000.0A	Type setting	□
56	P03.06	Stator resistor of motor	0.001~65.535Ω	Type setting	◇
57	P03.07	Rotor resistance of motor	0.001~65.535Ω	Type setting	◇
58	P03.08	Stator and rotor inductance of motor	0.1~6553.5mH	Type setting	◇

No.	Code	Describing LED/OLED Keyboard display	Setting range	Factory setting	Change
59	P03.09	Mutual inductance for stator and rotor of motor	0.1~6553.5mH	Type setting	◇
60	P03.10	No-load current of the motor	0.01~655.35A	Type setting	◇
61	P03.11	Self-study of motor parameter	0: No operation 1: Comprehensive self-study of parameter 2: Static self-study of parameter	0	□

6-1-6. P04 group Vector control parameter

No.	Code	Describing LED/OLED Keyboard display	Setting range	Factory setting	Change
62	P04.00	Proportional gain of speed ring 1	0~100	20	◇
63	P04.01	Integral time of speed ring 1	0.01~10.00s	0.50s	◇
64	P04.02	Low frequency of low switch	0.00Hz~P04.05	5.00Hz	◇
65	P04.03	Proportional gain of speed ring 2	0~100	25	◇
66	P04.04	Integral time of speed ring 2	0.01~10.00s	1.00	◇

No.	Code	Describing LED/OLED Keyboard display	Setting range	Factory setting	Change
67	P04.05	High frequency of low switch	P04.02~P01.07 (maximum frequency)	10.00Hz	◇
68	P04.06	Compensation factor of VC slippage	50%~200%	100%	◇
69	P04.07	Setting for upper limit of torque	0.0~200.0%(rated current of transducer)	150.0%	◇

6-1-7. P05 group V/F control parameter

No.	Code	Describing LED/OLED Keyboard display	Setting range	Factory setting	Change
70	P05.00	Setting of V/F curve	00: V/F curve of line 1: V/F curve of multipoints 2: 1. V/F curve for dropping torque of 2 power 3: 1. V/F curve for dropping torque of 4 power 4: 1. V/F curve for dropping torque of 6 power 5: 1. V/F curve for dropping torque of 8 power 6: 2 V/F curve for dropping torque of 0 power		□
71	P05.01	Torque boost	0.0%:(automatic)0.1%~30.0%	0.0%	◇
72	P05.02	Deadline of torque boost	0.0%~50.0%(rated frequency of relative motor)	20.0%	□
73	P05.03	Limit for compensation of V/F slippage	0.0~200.0%	0.0%	◇
74	P05.04	Threshold value for low frequency of restricting vibration	0~500	5	◇

No.	Code	Describing LED/OLED Keyboard display	Setting range	Factory setting	Change
75	P05.05	Threshold value for high frequency of restricting vibration	0~500	100	◇
76	P05.06	Clipping value of restricting vibration	0~10000	5000	◇
77	P05.07	Demarcation frequency for low and high frequency of restricting vibration	0.00Hz~ P01.07(maximum frequency)	12.50 Hz	◇
78	P05.08	Restrict vibration	0: restricting vibration is valid 1: restricting vibration is invalid	1	◇
79	P05.09	V/F frequency point 1	0.00HZ~P05.11	0.00H Z	□
80	P05.10	V/F voltage point 1	0.0~100.0%	0.0%	□
81	P05.11	V/F frequency point 2	P5.09~P05.13	0.00H Z	□
82	P05.12	V/F voltage point 2	0.0~100.0%	0.0%	□
83	P05.13	V/F frequency point 3	P05.11~P03.02	0.00H Z	□
84	P05.14	V/F voltage point 3	0.0~100.0%	0.0%	□

No.	Code	Describing LED/OLED Keyboard display	Setting range	Factory setting	Change
85	P05.15	Selection for energy-saving operation	0: Failure to actuate 1:Automatic energy-saving operation	0	<input type="checkbox"/>

6-1-8. P06 group Input terminal group

No.	Code	Describing LED/OLED Keyboard display	Setting range	Factory setting	Change
86	P06.00	Function selection of DI1 terminal	0: No function 1: Forward running 2: Reverse run 3: Trilinear operation control 4: Forward JOG 5: Reverse JOG 6: Random parking 7: Fault resetting 8: Input of external fault 9: UP for frequency setting 10: DOWN for frequency setting 11: Removal for UP and DOWN of frequency setting 12: Terminal of multiple speed 1 13: Terminal of multiple speed 2 14: Terminal of multiple speed 3 15: Terminal of multiple speed 4 16: Temporary stop of PID control 17: Temporary stop of pendulous frequency (stop at current frequency)	1	<input type="checkbox"/>
87	P06.01	Function selection of DI2 terminal		2	<input type="checkbox"/>



No.	Code	Describing LED/OLED Keyboard display	Setting range	Factory setting	Change
88	P06.02	Function selection of DI3 terminal	18: Resetting of pendulous frequency (return to central frequency)	4	<input type="checkbox"/>
89	P06.03	Function selection of DI4 terminal	19: Prohibition of acceleration and deceleration 20: Prohibition of torque control 21: Temporary removal for UP and DOWN setting of frequency 22: DC brake of halt 23: Choice for terminal of acceleration and deceleration time 189 24: Choice for terminal of acceleration and deceleration time 2	0	<input type="checkbox"/>
90	P06.04	Filtering times of switching value	1~10	5	<input type="checkbox"/>
91	P06.05	Operation mode of terminal control	0: Control like two lines 1 1: Control like two lines 2 2: Trilinear control 1 3: Trilinear control 2	0	<input type="checkbox"/>

No.	Code	Describing LED/OLED Keyboard display	Setting range	Factory setting	Change
92	P06.06	Increasing + via clockwise rotation of encoder and terminal or decreasing via counterclockwise rotation of encoder and terminal	0.01 ~ 50.00Hz/s	0.50Hz/s	◇
93	P06.07	Low limiting value of AI1	0.00V ~ 10.00V	0.00V	◇
94	P06.08	Low limits of AI1 corresponds with the setting	-100.0% ~ 100.0%	0.0%	◇
95	P06.09	Upper limiting value of AI1	0.00V ~ 10.00V	10.00V	◇
96	P06.10	Upper limits of AI1 corresponds with the setting	-100.0% ~ 100.0%	100.0%	◇
97	P06.11	Filtering time of AI1 input	0.00s ~ 10.00s	0.10s	◇
98	P06.12	Low limiting value of AI2	0.00V ~ 10.00V	0.00V	◇
99	P06.13	Low limits of AI2 corresponds with the setting	-100.0% ~ 100.0%	0.0%	◇
100	P06.14	Upper limiting value of	0.00V ~ 10.00V	10.00V	◇

No.	Code	Describing LED/OLED Keyboard display	Setting range	Factory setting	Change
101	P06.15	Upper limits of AI2 corresponds with the setting	-100.0%~100.0%	100.0%	◇
102	P06.16	Filtering time of AI2 input	0.00s~10.00s	0.10s	◇
103	P06.17	Gain for simulated input 1 K1	0.00~300.00	100.00	◇
104	P06.18	Gain for simulated input 2 K2	0.00~300.00	100.00	◇

6-1-9. P07 group Human-computer interface group

No.	Code	Describing LED/OLED Keyboard display	Setting range	Factory setting	Change
105	P07.00	User password	0~65535	0	◇
106	P07.01	OLED shows language choice	0:Chinese 1:English	0	◇

No.	Code	Describing LED/OLED Keyboard display	Setting range	Factory setting	Change
107	P07.02	Copy of function parameter	0: No operation 1: Function parameter of this machine is delivered to OLED keyboard 2: Download function parameter of OLED keyboard onto this machine Notice: the parameter automatically returns to 0 after 1-2 operations have been finished.	0	<input type="checkbox"/>
108	P07.03	Function choice of 	0:JOG operation 1: Switch of forward and reverse rotation 2: Remove increasing+ via clockwise rotation or decreasing- via counterclockwise rotation-setting	0	<input type="checkbox"/>
109	P07.04	Function choice for halt of 	0: it is only effective for panel control 1: it is effective for panel control and terminal control 2: it is effective for panel control and communication control 3: it is effective for all control modes	0	<input type="checkbox"/>

No.	Code	Describing LED/OLED Keyboard display	Setting range	Factory setting	Change
110	P07.05	Choice for parameter showed by operation state	0~0x7FFF BIT0: operation frequency BIT1: setting frequency BIT2: busbar voltage BIT3: output voltage BIT4: output current BIT5: rotate speed of operation BIT6: output power BIT7: output torque BIT8: given value of PID BIT9: feedback value of PID BIT10: state of input terminal BIT11: state of output terminal BIT12: value of analog AI1 BIT13: value of analog AI2 BIT14: Current section of multiple speed BIT15: Setting value of torque	0x3FF	◇

No.	Code	Describing LED/OLED Keyboard display	Setting range	Factory setting	Change
111	P07.06	Choice for parameter showed by halt state	1~0x1FF BIT0: setting frequency BIT1: busbar voltage BIT2: state of input terminal BIT3: state of output terminal BIT4: given value of PID BIT5: feedback value of PID BIT6: value of analog AI1 BIT7: value of analog AI2 BIT8: Current section of multiple speed BIT9: Setting value of torque BIT10~ BIT15: Reservation	0xFF	◇
112	P07.07	First two fault types	0~24 0: Fault free 1: Protection for U phase of contravariant unit (E.oUP) 2: Protection for V phase of contravariant unit (E.oUP) 3: Protection for W phase of contravariant unit (E.oUP) 4: Overcurrent of acceleration (E.oC1) 5: Overcurrent of deceleration (E.oC2) 6: Overcurrent of constant speed (E.oC3) 7: Overvoltage of acceleration (E.oU1)		■
113	P07.08	The first two fault type			■

No.	Code	Describing LED/OLED Keyboard display	Setting range	Factory setting	Change
114	P07.09	Current fault type	8: Overvoltage of deceleration (E.oU2) 9: Overvoltage of constant speed (E.oU3) 10: undervoltage fault of generatrix (E.LU) 11: Motor overload (E.oL1) 12: Overload of transducer (E.oL2) 13: Default phase at output side (E.PHI) 14: Default phase at input side (E.PHo) 15: Overheating of rectification module (E.oH1) 16: Fault for overheating of contravariant module (E.oH2) 17: External fault (E.SET) 18: Communication fault (E.CE) 19: Detection fault of current (E.ItE) 20: fault for self-study of motor (E.tE) 21: operation fault of EEPROM (E.EEP) 22: Fault for break line of PID feedback (E.PId) 23: Brake unit fault (E.bCE) 24: Reservation (END)		■

No.	Code	Describing LED/OLED Keyboard display	Setting range	Factory setting	Change
115	P07.10	Operation frequency of current fault		0.00Hz	72
116	P07.11	Output current of current fault		0.0A	■
117	P07.12	Busbar voltage of current fault		0.0V	■
118	P07.13	State for input terminal of current fault		0	■
119	P07.14	State for output terminal of current fault		0	■

6-1-10. P08 group output terminal group

No.	Code	Describing LED/OLED Keyboard display	Setting range	Factory setting	Change
120	P08.00	Output choice of relay	0: No output 1: Motor is at the state of forward rotation 2: Motor is at the state of reverse rotation 3: Fault output 4: Level detection of frequency and PDT output 5: Reach Frequency 6: Zero-speed operation 7: Reach frequency of upper limit 8: Reach frequency of lower limit 9: frequency of lower limit setting reached 9-10 reservation	3	◇

No.	Code	Describing LED/OLED Keyboard display	Setting range	Factory setting	Change
121	P08.01	Output choice of AO1	0: operation frequency 1: setting frequency 2 :rotate speed of operation 3: output current 4: output voltage 5: output power 6 :output torque 7: Input value of analog AI1 8: Input value of analog AI2 9~10: Reservation	0	◇
122	P08.02	Lower limit for output of AO1	0.0%~100.0%	0.0%	◇
123	P08.03	Lower limit corresponds with output of AO1	0.00V ~10.00V	0.00V	◇
124	P08.04	Upper limit for output of AO1	0.0%~100.0%	100.0%	◇
125	P08.05	Upper limit corresponds with output of AO1	0.00V ~10.00V	10.00V	◇

6-1-11. P09 group Enhancement group

No.	Code	Describing LED/OLED Keyboard display	Setting range	Factory setting	Change
126	P09.00	Acceleration time 2	0.1~3600.0s	Type setting	◇
127	P09.01	Deceleration time 2	0.1~3600.0s	Type setting	◇
128	P09.02	Acceleration time 3	0.1~3600.0s	Type setting	◇
129	P09.03	Deceleration time 3	0.1~3600.0s	Type setting	◇
130	P09.04	Acceleration time 4	0.1~3600.0s	Type setting	◇
131	P09.05	Deceleration time 4	0.1~3600.0s	Type setting	◇
132	P09.06	Operation frequency of JOG	0.00~P01.07 (maximum frequency)	5.00Hz	◇
133	P09.07	Acceleration time of JOG operation	0.1~3600.0s	Type setting	◇
134	P09.08	Deceleration time of JOG operation	0.1~3600.0s	Type setting	◇
135	P09.09	Hopping frequency	0.00~P01.07 (maximum frequency)	0.00Hz	◇

No.	Code	Describing LED/OLED Keyboard display	Setting range	Factory setting	Change
136	P09.10	Range of hopping frequency	0.00~P01.07 (maximum frequency)	0.00Hz	◇
137	P09.11	Range of pendulous frequency	0.0~100.0%(relative setting frequency)	0.0%	◇
138	P09.12	Range of jumping frequency	0.0~50.0% (relative range of pendulous frequency)	0.0%	◇
139	P09.13	Rise time pendulous frequency	0.1~3600.0s	5.0s	◇
140	P09.14	Fall time pendulous frequency	0.1~3600.0s	5.0s	◇
141	P09.15	Times for automatic reset of the fault	0~3	0	◇
142	P09.16	Setting for interval of automatic reset of the fault	0.1~100.0s	1.0s	◇
143	P09.17	Detection value for level of FDT	0.00~ P01.07 (maximum frequency)	50.00Hz	◇

No.	Code	Describing LED/OLED Keyboard display	Setting range	Factory setting	Change
144	P09.18	Detection value for hysteresis of FDT	0.0~100.0% (FDT level)	5.0%	◇
145	P09.19	Frequency reaches detection degree	0.0~100.0% (maximum frequency)	0.0%	◇
146	P09.20	Voltage of brake valve	115.0~140.0% (voltage of standard generatrix) (380V series)	130.0%	◇
			115.0~140.0% (voltage of standard generatrix) (220V series)	120.0%	◇
147	P09.21	Display coefficient of rotate speed	0.1~999.9% machinery rotate speed =120*operation frequency*P09.21/pole number	100.0%	◇

6-1-12. P10 group control group of PID

No.	Code	Describing LED/OLED Keyboard display	Setting range	Factory setting	Change
148	P10.00	Selection for given power supply of PID	0:keyboard presetting (P10.01) 1: Presetting for simulated channel AI1 2: Presetting for simulated channel AI2 3: Presetting of remote communication 4: Presetting of multistep speed	0	◇
149	P10.01	Keyboard presets the PID presetting	0.0%~100.0%	0.0%	◇
150	P10.02	Selection for feedback source of PID	0: Feedback for simulated channel AI1 1: Feedback for simulated channel AI2 2: Feedback of AI1+AI2 3: Feedback of remote communication	0	◇
151	P10.03	Selection for output characteristics of PID	0:PID output is positive 1:PID output is negative	0	◇
152	P10.04	Proportional gain (Kp)	0.00~100.00	1.00	◇

No.	Code	Describing LED/OLED Keyboard display	Setting range	Factory setting	Change
153	P10.05	Integral time (Ti)	0.01~10.00s	0.10s	◇
154	P10.06	Derivative time (Td)	0.00~10.00s	0.00s	◇
155	P10.07	Sampling period (T)	0.01~100.00s	0.10s	◇
156	P10.08	Deviation limit of PID control	0.0~100.0%	0.0%	◇
157	P10.09	Detection value for break line of feedback	0.0~100.0%	0.0%	◇
158	P10.10	Detection time for break line of feedback	0.0~3600.0s	1.0s	◇

6-1-13. P11 group control group of multistep speed

No.	Code	Describing LED/OLED Keyboard display	Setting range	Factory setting	Change
159	P11.00	Multistep speed 0	-100.0~100.0%	6	◇
160	P11.01	Multistep speed 1	-100.0~100.0%	12	◇
161	P11.02	Multistep speed 2	-100.0~100.0%	18	◇

No.	Code	Describing LED/OLED Keyboard display	Setting range	Factory setting	Change
162	P11.03	Multistep speed 3	-100.0~100.0%	24	◇
163	P11.04	Multistep speed 4	-100.0~100.0%	30	◇
164	P11.05	Multistep speed 5	-100.0~100.0%	36	◇
165	P11.06	Multistep speed 6	-100.0~100.0%	42	◇
166	P11.07	Multistep speed 7	-100.0~100.0%	48	◇
167	P11.08	Multistep speed 8	-100.0~100.0%	54	◇
168	P11.09	Multistep speed 9	-100.0~100.0%	60	◇
169	P11.10	Multistep speed 10	-100.0~100.0%	66	◇
170	P11.11	Multistep speed 11	-100.0~100.0%	72	◇
171	P11.12	Multistep speed 12	-100.0~100.0%	78	◇
172	P11.13	Multistep speed 13	-100.0~100.0%	84	◇
173	P11.14	Multistep speed 14	-100.0~100.0%	90	◇
174	P11.15	Multistep speed 15	-100.0~100.0%	100	◇

6-1-14. P12group communication parameter group

No.	Code	Describing LED/OLED Keyboard display	Setting range	Factory setting	Change
175	P12.00	Setting for Baud rate of communication	0:1200bps 1:2400bps 2:4800bps 3:9600bps 4:19200bps 5:38400bps	4	◇

No.	Code	Describing LED/OLED Keyboard display	Setting range	Factory setting	Change
176	P12.01	Setting for bit check of data	0: Without verification (N, 8, 1) for RTU 1: Even parity check (E, 8, 1) for RTU 2: Odd parity check (O, 8, 1) for RTU 3: Without verification (N, 8, 2) for RTU 4: Even parity check (E, 8, 2) for RTU 5: Odd parity check (O, 8, 2) for RTU 6: Without verification (N, 7, 1) for ASCII 7: Even parity check (E, 7, 1) for ASCII 8: Odd parity check (O, 7, 1) for ASCII 9: Without verification (N, 7, 2) for ASCII 10: Even parity check (E, 7, 2) for ASCII 11: Odd parity check (O, 7, 2) for ASCII 12: Without verification (N, 8, 1) for ASCII 13: Even parity check (E, 8, 1) for ASCII 14: Odd parity check (O, 8, 1) for ASCII ASCII	1	◇

No.	Code	Describing LED/OLED Keyboard display	Setting range	Factory setting	Change
176	P12.01	Setting for bit check of data	15: Without verification (N,8,2)for ASCII 16: Even parity check (E,8,2)for ASCII 17: Odd parity check (O,8,2)for	1	◇
177	P12.02	Communication address of this method	1~247, 0 is broadcast address	1	◇
178	P12.03	Delay for communication response	0~200ms	5ms	◇
179	P12.04	Delayed fault time of communication	0.0 (invalid) , 0.1~100.0s	0.0s	◇
180	P12.05	Disposal for transmission error	0: alarm and random parking 1: No alarm and continuous operation 2: Halt according the halt method without alarm(only for communication method) 3: Halt according the halt method without alarm(for all control methods)	1	◇

No.	Code	Describing LED/OLED Keyboard display	Setting range	Factory setting	Change
181	P12.06	Disposal for transmission response	0: writing operation with response 1: writing operation without response	0	◇

6-1-15. P13 group Protection function group

No.	Code	Describing LED/OLED Keyboard display	Setting range	Factory setting	Change
182	P13.00	Input the protection selection of default phase	0: Prohibit 1: Permit	1	□
183	P13.01	Output the protection selection of default phase	0: Prohibit 1: Permit	1	□
184	P13.02	protection selection of motor overload	0: No protection 1: Ordinary motor (having compensation with low speed) 2: variable frequency motor (without compensation with low speed)	2	□
185	P13.03	Protective current of motor overload	20.0%~ 120.0%(rated current of motor)	100.0%	◇

No.	Code	Describing LED/OLED Keyboard display	Setting range	Factory setting	Change
186	P13.04	Under-clocking point for instant power failure	70.0~110.0%(voltage of standard generamatrix)	80.0%	◇
187	P13.05	Descent rate for frequency of instant power failure	0.00Hz~P01.07(Maximum frequency)	0.00Hz	◇
188	P13.06	Protection for overvoltage and speed reduction	0: Prohibit 1: Permit	0	◇
189	P13.07	Protective for voltage of overvoltage and speed reduction	110~150% (380V series)	130%	◇
			110~150% (220V series)	120%	◇
190	P13.08	Level of automatic current limiting	100~200%	G type:160% P type:120%	◇
191	P13.09	Descent rate for frequency of current limiting	0.00~100.00Hz/s	10.00Hz/s	◇
192	P13.10	Choice for the selection of current limiting activity	0: current limiting is always effective 1: current limiting is ineffective for constant speed	0	◇

6-1-16. P14 group function group of water supply

No.	Code	Describing LED/OLED Keyboard display	Setting range	Factory setting	Change
193	P14.00	Operation function of PID	0: halt without operation 1: halt with operation	0	◇
194	P14.01	Awakening frequency	dormancy frequency (P14.03) ~ maximum frequency (P01.07)	10.00Hz	◇
195	P14.02	Delay time of awakening	0.0s~3600.0s	1000.0s	◇
196	P14.03	Dormancy frequency	0.00Hz~awakening frequency (P14.01)	5.00Hz	◇
197	P14.04	Delay time of dormancy	0.0s~3600.0s	50 0.0s	◇

6-1-17. P15 group manufacturer's function group

No.	Code	Describing LED/OLED Keyboard display	Setting range	Factory setting	Change
198	P15.00	Manufacturer password	0~65535	*****	■

Chapter7 EMC(Electro Magnetic Compatibility)

7-1. Definition

7-2. Electromagnetic compatibility refers to the operation of electrical equipment in the environment with electromagnetic interference; it doesn't disturb the electromagnetic environment and stabilize its ability on realizing its function.

7-2. Introduction of EMC standard

Based on the requirement of national standard GB/T12668.3, AC frequency vector inverter should meet the requirement of electromagnetic interference and anti-electromagnetic interference.

The existing products of our company implements the latest international standard: IEC/EN61800-3:2004 (Adjustable speed electrical power drive systems part 3: EMC requirements and specific test methods) and national standard GB/T12668.3. IEC/EN61800-3 mainly inspects AC frequency vector inverter from electromagnetic interference and anti-electromagnetic interference. Electromagnetic interference makes test on the radiated interference, conducted interference and harmonic interference of AC frequency vector inverter (for civil AC frequency vector inverter).

anti-electromagnetic interference mainly makes test on conducted immunity, radiated susceptibility, SURGE,

quick and sudden EFT, ESD immunity and immunity at the bottom of power supply of AC frequency vector inverter (specific test project includes : 1. Test on immunity for temporary reduction, interruption and change of AC frequency vector inverter; 2. Test on the immunity at the breach of commutation; 3. Test on the immunity of harmonic wave input; 4. Test on the change of input frequency; 5. Test on imbalance of input voltage; 6. Test on immunity of input voltage). The test is made according to the strict requirement of the above IEC/EN61800-3; products of our company are installed and used based on the guidance shown in 7.3 and they will have good electromagnetic compatibility under normal industrial environment.

7-3.EMC guidance

7-3-1. Influence of harmonic wave

Higher harmonic of the power supply will damage AC frequency vector inverter; as a result, it is suggested to install AC input reactor for the place with low quality of power grid.

7-3-2.Electromagnetic interference and installation notes

Electromagnetic interference has two types; one is the interference for electromagnetic noise of the surrounding to AC frequency vector inverter; and the

other is the interference caused by AC frequency vector inverter to surrounding devices

Installation notes:

1) ground lead of AC frequency vector inverter and other electrical products should be connected with the ground well;

2) Input and output power line for the motive power of AC frequency vector inverter and signal line of weak current (like control wiring) should not be laid horizontally and lay them vertically if necessary.

3) power line for the output of AC frequency vector inverter is suggested to use shield cable or shielding power line of steel tube; and the shielding layer should be connected with ground reliably; leading wire for equipment disturbed is suggested to use shielding control line with twisted pair and the shielding layer should be connected with ground reliably ;

4) It is required to install output filter or electric reactor for the motor whose cable length is more than 100m

7-3-3. Solution for the interference of surrounding electromagnetic equipment on AC frequency vector inverter

Generally speaking, the reason for causing electromagnetic effect on AC frequency vector inverter is there is a lot of relays, contactors or electromagnetic brakes surrounding AC frequency vector inverter; the

following methods is suggested to use when AC frequency vector inverter is disturbed by them and operates wrongly:

1) install surge suppression on the device giving interference;

2) Install filter on the input terminal of AC frequency vector inverter; please refer to 7.3.6 for operation detail;

3) Use shielding cable for control signal line and leading wire for detection circuit of AC frequency vector inverter and connect the shielding layer to the ground reliably.

7-3-4. Solution for the interference of AC frequency vector inverter on its surrounding electromagnetic equipment

the noise in this part is divided into two types: one is the radiated interference of AC frequency vector inverter; and the other is the conducted interference of AC frequency vector inverter; the interference makes the surrounding electrical equipment have electromagnetic or electrostatic induction; then the interference can further make the device have wrong operation. Please refer to the following solutions for different interferences:

1) generally speaking, meter, receiver and sensor used for measuring has weak signal; and they are easy to interfere and cause wrong operation when they are near to AC frequency vector inverter or in the same control cabinet with AC frequency vector inverter; it is suggested

to use the following methods to solve it: be away from the interference as far as possible; don't lay the signal line and power line horizontally; in particular, don't bind them together; signal line and power line uses shielding cable and connects with the ground well; add ferrite bead to the output side of AC frequency vector inverter (blanketing frequency should be within 30~1000MHz) and roll 2-3 rings; EMC output filter can be installed for worse condition.

2) When the equipment disturbed and AC frequency vector inverter uses the same power supply, it will also cause conducted interference; if the methods mentioned above can't eliminate the interference, then install EMC filter between AC frequency vector inverter and power supply (please refer to 7.3.6 for detail of type operation) .

3)Independent grounding of external equipment can eliminate the interference caused by leak current which is caused by the grounding wire of AC frequency vector inverter when they share the ground together.

7-3-5. Leakage current and disposal

Leakage current of AC frequency vector inverter has two types: one is leakage current for the ground; and the other in leakage current among lines.

1) Factors affecting leakage current for ground and solution:

The wire and the ground has distributed capacitance; the bigger the distributed capacitance, the bigger the leakage current; effectively shorten the distance between

AC frequency vector inverter and motor to reduce the distributed capacitance. The bigger the carrier frequency, the bigger the leakage current. Reduce carrier frequency to reduce the leakage current. However, reducing carrier frequency can cause the increase of motor noise; please pay attention to installing electric reactor is also an effective way to solve the leakage current. leakage current will increase with the increase of loop current; as a result, corresponding leakage current will be big when the motor power is large.

2) Factors affecting leakage current among lines and solution:

Output wirings have distributed capacitance; if the current passing through the circuit includes higher harmonic, then it is very likely to cause resonance and then result in leakage current. At this moment, if thermal relay is used, it may make it have wrong action.

The solution is to reduce carrier frequency or install output reactor. It is suggested not to install thermal relay before the motor when AC frequency vector inverter is used. And use the protective function for overcurrent of electron of AC frequency vector inverter.

7-3-6. Precautions for installing EMC input filter at the input terminal of the power supply :

1) Notice: rated value must be strictly followed when the filter is sued; mental case ground of filter should be connect with metal ground of installation

cabinet because filter belongs to I electrical equipment; moreover, it should have good continuousness of electric conduction, or it may have electric shock hazard or seriously affect EMC effect; it is discovered via EMC test that filter ground and ground at PE terminal of AC frequency vector inverter should be connected to the same public ground, or it will seriously affect EMC effect.

2) Install the filter at the input terminal for the power supply of AC frequency vector inverter as close as possible.

Chapter 8 Failure checking and removal

8-1. Failure information and removal method

No.	Failure code	Failure type	Possible reason of the failure	Countermeasures
1	E.oUP	U-phase protection of contravariant unit	1. Acceleration is too fast 2. Internal breakdown for IGBT of this phase 3. Interference causes wrong activity 4. whether the grounding is good enough	1. Increase acceleration time 2. Look for help 3. Inspect whether peripheral equipment has strong interference source
2	E.oUP	V-phase protection of contravariant unit		
3	E.oUP	W-phase protection of contravariant unit		
4	E.oC1	Overcurrent of acceleration	1. Acceleration is too fast 2. Low network voltage 3. Low power of AC frequency vector inverter	1. Increase acceleration time 2. Inspect input power 3. Select AC frequency vector inverter with a larger power
5	E.oC2	Overcurrent of constant speed	1. Deceleration is too fast 2. Large torque of load inertia 3. Low power of AC frequency vector inverter	1. Increase deceleration time 2. Add suitable dynamic braking component 3. Select AC frequency vector inverter with a larger power

No.	Failure code	Failure type	Possible reason of the failure	Countermeasures
6	E.oC3	Overcurrent of constant speed	<ol style="list-style-type: none"> 1. Mutation or abnormality of the load 2. Low network voltage 3. Low power of AC frequency vector inverter 	<ol style="list-style-type: none"> 1. Inspect the load or reduce the mutation of the load 2. Inspect input power 3. Select AC frequency vector inverter with a larger power
7	E.oU1	Overvoltage of acceleration	<ol style="list-style-type: none"> 1. Abnormal input voltage 2. Restart the motor in rotation after instant power off 	<ol style="list-style-type: none"> 1. Inspect input power 2. Avoid stopping and restarting
8	E.oU2	Overvoltage of deceleration	<ol style="list-style-type: none"> 1. Deceleration is too fast 2. Large inertia of load 3. Abnormal input voltage 	<ol style="list-style-type: none"> 1. Increase deceleration time 2. Increase dynamic braking component 3. Inspect input power
9	E.oU3	Overvoltage of constant speed	<ol style="list-style-type: none"> 1. Abnormal change of input voltage 2. Large inertia of load 	<ol style="list-style-type: none"> 1. Install input reactor 2. Add suitable dynamic braking component
10	E.LU	Undervoltage fault of generatrix	<ol style="list-style-type: none"> 1. Low network voltage 	<ol style="list-style-type: none"> 1. Inspect input power of power grid
11	E.oL1	Motor overload	<ol style="list-style-type: none"> 1. Low network voltage 2. Incorrect setting for rated current of the motor 3. Motor block or too large load sudden 	<ol style="list-style-type: none"> 1. Inspect network voltage 2. Set rated current of the motor again 3. Inspect load and adjust lifting capacity of the

No.	Failure code	Failure type	Possible reason of the failure	Countermeasures
			change 4. High-power heavy truck	torque 4. Select proper motor
12	E.oL2	overload of AC frequency vector inverter	1. Acceleration is too fast 2. Restart the motor in rotation 3. Low network voltage 4. Too big load	1. increase acceleration time 2. Avoid stopping and restarting 3. Inspect network voltage 4. Choose AC frequency vector inverter with a much bigger power
13	E.PHI	Default phase at the input side	Input R, S and T has default phase	1. Inspect input power 2. Inspect installation wiring
14	E.PHo	Default phase at the output side	Output for U, V and W default phase(or load three-phase is seriously asymmetric	1. Inspect output wiring 2. Inspect motor and cable
15	E.oH1	Overheating of rectifier module	1. Instant overcurrent of AC frequency vector inverter 2. Output three-phase has interphase or grounded short circuit 3. Block of air channel or fan damage 4. Too high temperature 5. Looseness for cable of control panel or plug-in unit 6. Damage of auxiliary power supply and	Refer to countermeasures of overcurrent 2. Wire again 3. Dredge air flue or replace the fan 4. Reduce environment temperature 5. Inspect and connect again 6. look for service 7. look for service 8. look for service

No.	Failure code	Failure type	Possible reason of the failure	Countermeasures
			undervoltage driving voltage 7. Direct connection for bridge arm of power module 8. Abnormal control panel	
16	E.oH2	Overheating of contravariant module (only for 11kw~37kw)	1. Instant overcurrent of AC frequency vector inverter 2. Output three-phase has interphase or grounded short circuit 3. Block of air channel or fan damage 4. Too high temperature 5. Looseness for cable of control panel or plug-in unit 6. Damage of auxiliary power supply and undervoltage driving voltage 7. Direct connection for bridge arm of power module 8. Abnormal control panel	1. Refer to countermeasures of overcurrent 2. Wire again 3. Dredge air flue or replace the fan 4. Reduce environment temperature 5. Inspect and connect again 6. look for service 7. look for service 8. look for service
17	E.SET	External	1. Activity for external input terminal of SI	1. Inspect the input of external equipment

Chapter 8 Failure checking and removal

No.	Failure code	Failure type	Possible reason of the failure	Countermeasures
18	E.CE	Communication fault	<ol style="list-style-type: none"> 1. Improper setting of Baud rate 2. Adopt the communication mistake of serial communication 3. Long-term interrupt of communication 	<ol style="list-style-type: none"> 1. Set proper Baud rate 設定 2. Press  to reset and look for service 3. Inspect the wire at the communication interface
19	E.oCC	Fault of current detection on circuit	<ol style="list-style-type: none"> 1. Bad contact for connector of control panel 2. Damage of auxiliary power 3. Damage of Hall device 4. Abnormal amplifying circuit 	<ol style="list-style-type: none"> 1. Inspect connector and insert the cable again 2. Look for service 3. Look for service 4. Look for service
20	E.TE	Fault for self-study of motor	<ol style="list-style-type: none"> 1. Mismatching between the motor capacity and capacity of AC frequency vector inverter 2. Improper setting for rated parameter of the motor 3. Large deviation between the parameter obtained by self-study and standard parameter 	<ol style="list-style-type: none"> 1. Change the type of AC frequency vector inverter 2. Set rated parameter based on the nameplate of motor 3. Make the motor empty and recognize it again 4. Check motor

No.	Failure code	Failure type	Possible reason of the failure	Countermeasures
			4. Overtime self-study	connection and parameter setting
21	E.EEP	Reading and writing fault of EEPROM	1. Mistake for the reading and writing of control parameter 2. Damage of EEPROM	1. Press  to reset and look for service 2. Look for service
22	E.PId	Break-line fault for feedback of PID	1. Break-line for feedback of PID 2. Disappearance for feedback source of PID	1. Inspect break-line for feedback of PID 2. Inspect feedback source of PID
23	E.bCE	Brake unit fault	1. Fault of brake circuit and damage of brake pipe 2. Small external brake resistor value	1. Inspect brake unit and renew new brake pipe 2. Increase brake resistor
24	P. of F	Shutdown display	1. Low input voltage 2. Improper setting of parameter 3. Shutdown display	1. Inspect whether the voltage is correct 2. Inspect whether the parameter is correct
25	END	Manufacturer's preservation		



Version number:YS20130225 First edition first printing

*Specifications subject to errors omissions, please understand

For more technical information, please visit [www. powtech. cn](http://www.powtech.cn)

— CE FC RoHS —

Shen Zhen Powtech Co.,Ltd

Address: 3A Floor, Block B Xin Bao Sheng NO.233 Xi Xiang Avenue
Bao An District Shen Zhen China Post Code: 518000

Zip:518000

Tel: (+86) 0755-27586830-824

Fax: (+86) 0755-29960597

<http://www.powtech.cn/en/index.html>

Email: info@powtech.cn

MSN: service@powtech.cn

Skype: Powtechok

